

Physical Specifications

Part Number: AGM TED1228SP
 Length: 165 ± 2 mm (6.50 inches)
 Width: 125 ± 2 mm (4.92 inches)
 Height: 175 ± 2 mm (6.89 inches)
 Weight: ~ 8.6 kg (18.96 lbs)

Standard case material is flame retardant to (UL94) HBO.
 The TED Batteries range provide an extremely reliable and versatile valve regulated lead acid battery. Their unique construction and sealing techniques ensures that no electrolyte leakage can occur, provides safe and effective operation in any orientation and meets all requirements of the International Air Transport Association Dangerous Goods Regulations to allow transportation by air.



Specifications

Terminal Type: Standard T12 (M5) or any suitable terminal (at customer request)

Design Floating Life 20°C (68°F): 9 Years

Maxim Discharge Current: 422A/5sec.

Internal Resistance: Approximative 14mΩ

Cycle Use: Initial Charging Current Less Than 8.40A • Voltage 14.4÷14.8 at 25°C (77°F) • Temperature Coefficient -30mV/°C
 Standby Use: No Limit on Initial Charging Current Voltage 13.5÷13.8V at 25°C (77°F) • Temperature Coefficient -20mV/°C
 Capacity Affected by Temperature 40°C (104°F) 103% 25°C (77°F) 100% 0°C (32°F) 86%

Self Discharge: TED Batteries may be stored for up to 6 months at 25°C (77°F) and than refresh charge is required. For higher temperatures, the time interval will be shorter.

Rated Capacity

28.0 Ah/1.40A	20hr	1.80V/cell 25°C/77°F
26.0 Ah/2.60A	10hr	1.80V/cell 25°C/77°F
23.8 Ah/4.76A	5hr	1.75V/cell 25°C/77°F
21.4 Ah/7.14A	3hr	1.75V/cell 25°C/77°F
17.6 Ah/17.6A	1hr	1.60V/cell 25°C/77°F

Discharge Characteristics

Operating Temperature Range
Charge: 0°C÷40°C (5°F÷104°F)
Storage: -15°C÷40°C (5°F÷104°F)
Nominal: 25°C±3°C (77°F±5°F)
Discharge: -15°C÷50°C (5°F÷122°F)

T12 Terminal

Unit: mm [inches]

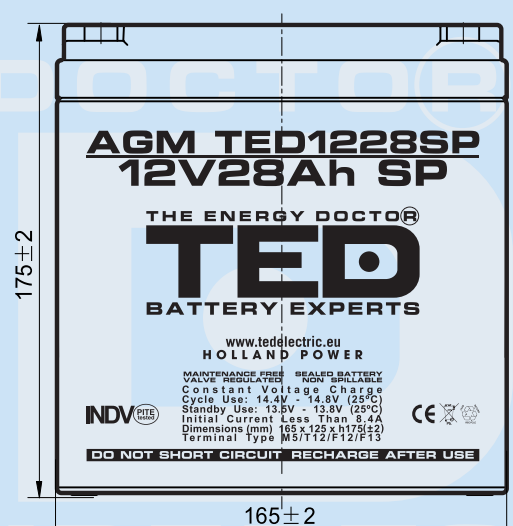
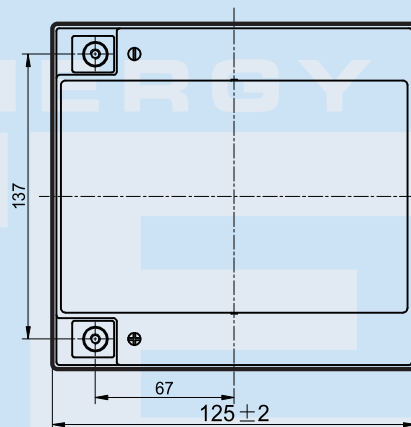
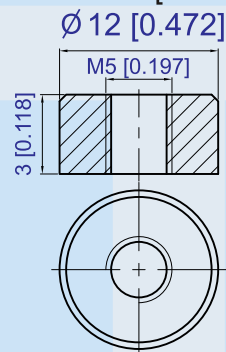

Constant Current Discharge (Amperes) at 25°C

F.V/Time	5 min	10 min	15 min	20 min	30 min	45 min	1h	2h	3h	4h	5h	6h	8h	10h	20h
1.85V/cell	53.3	40.9	33.9	29.3	22.7	16.7	14.1	8.33	6.52	5.30	4.32	3.75	3.02	2.53	1.39
1.80V/cell	71.6	52.3	41.0	34.7	26.8	19.4	15.8	9.09	7.01	5.66	4.64	4.02	3.21	2.60	1.40
1.75V/cell	80.7	57.5	44.8	37.3	27.8	20.2	16.5	9.42	7.14	5.78	4.76	4.13	3.26	2.67	1.41
1.70V/cell	88.9	62.7	47.8	39.2	28.9	21.0	17.0	9.66	7.34	5.94	4.88	4.22	3.31	2.73	1.44
1.67V/cell	98.0	67.6	50.8	41.6	30.5	21.5	17.4	9.80	7.65	6.14	5.01	4.31	3.36	2.78	1.46
1.60V/cell	108.1	73.4	54.3	44.4	32.2	22.4	17.6	10.2	7.88	6.33	5.18	4.40	3.39	2.81	1.47

Constant Power Discharge (Watts) at 25°C

F.V/Time	5 min	10 min	15 min	20 min	30 min	45 min	1h	2h	3h	4h	5h	6h	8h	10h	20h
1.85V/cell	97.5	75.6	63.3	55.3	43.2	32.1	27.2	16.17	12.70	10.36	8.47	7.37	5.97	5.00	2.75
1.80V/cell	129.5	95.5	75.4	64.4	50.2	37.1	30.3	17.53	13.59	11.00	9.05	7.87	6.31	5.15	2.77
1.75V/cell	142.9	103.3	81.4	68.6	51.7	38.1	31.5	18.11	13.78	11.21	9.26	8.06	6.41	5.28	2.79
1.70V/cell	153.0	110.0	85.7	71.6	53.5	39.5	32.4	18.53	14.14	11.48	9.48	8.22	6.49	5.38	2.84
1.67V/cell	166.3	117.6	90.4	75.4	56.0	40.1	32.9	18.68	14.68	11.83	9.70	8.37	6.58	5.48	2.88
1.60V/cell	179.2	124.8	95.1	79.5	58.7	41.6	33.1	19.39	15.06	12.17	9.99	8.53	6.63	5.53	2.89

Discharge Characteristics

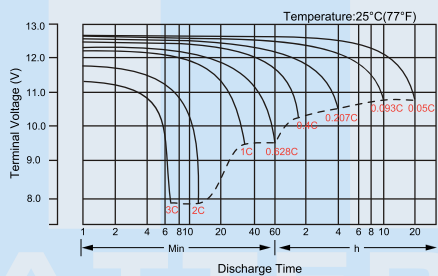

Float Charge Characteristics

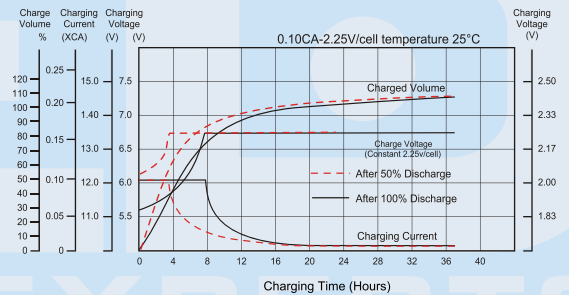

Temperature Effects in Relation to Battery Capacity

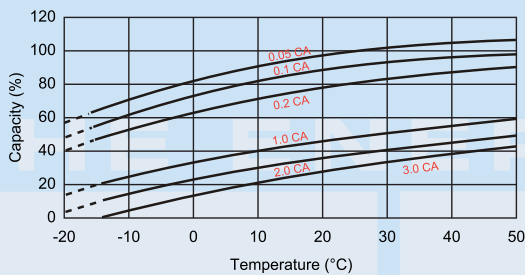

Effect of Temperature on Long Term Float Life

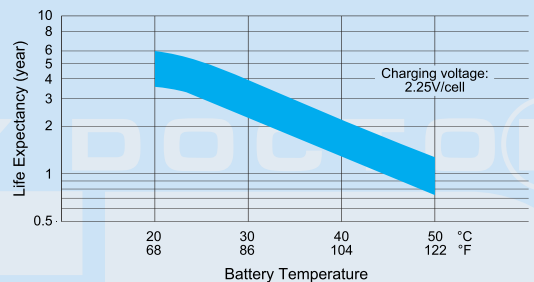

Cycle Life in Relation to Depth of Discharge

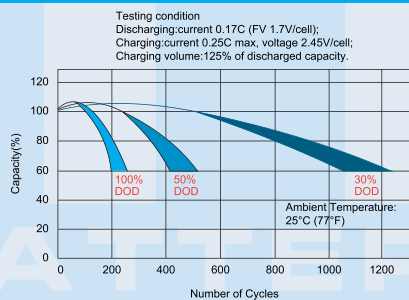

General Relation of Capacity vs Storage Time

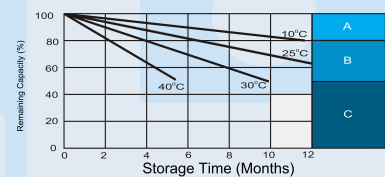

- A** No supplementary required (Carryout supplementary charge before use if 100% capacity is required.)
- B** Supplementary charge required before use. Optional charging way as below:
 1. Charged for above 3 days at limited current 0.25CA and constant voltage 2.25V/cell.
 2. Charged for above 20 hours at limited current 0.25CA and constant voltage 2.45V/cell.
 3. Charged for 8-10 hours at limited current 0.05 CA.
- C** Supplementary charge may often fail to recover the capacity. The battery should never be left standing till this is reached.